

# LAMP Damper Hinge HG-JHW16SG Installation Instructions

HG-JHW16SG damper hinge was designed and manufactured with Sugatsune's utmost care in order to give you a high performance and smooth operation on a long time basis. We ask you to follow these instructions for the best possible results and carefree use throughout its lifetime.

## Safety recommendations

- Please use this damper hinge only within the specifications shown in this manual.
- Do not disassemble.
- Do not close the door violently or it can cause damage to the product.

## Warranty

- HG-JHW16SG damper hinge was produced with a particular attention to its quality. Should you however experience any difficulty, please refer to your local supplier or Sugatsune Export Department (export@sugatsune.co.jp).
- The liability of Sugatsune is limited to the replacement of the damper hinge itself.
- Sugatsune cannot accept any liability for damage incurred while using this damper hinge.
- Standard warranty is for one-year period from the date of shipment.

## ⚠ Checking before the installation

Any failure to observe the following precautions may result in personal injury or damage to the cabinet.

- The product can be fitted to any of the three types of doors shown at right.
- Use the product within the prescribed load torque range (See the table in [2.Specifications](#)). An excessive load torque can cause damage to the product.
- Provide a door stopper to prevent the product from turning beyond the prescribed range (See [3.Damper Effective Angle](#) and [6.Application Examples](#) ).
- When more than one hinge is used for a door, fit them paying attention to the shaft alignment. An off-center shaft can increase the load or prevent smooth hinge operation.

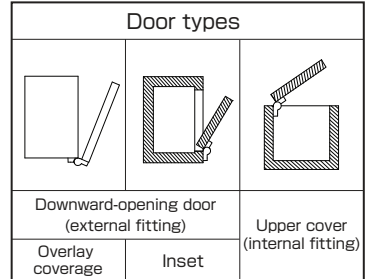

## 1. Dimensions

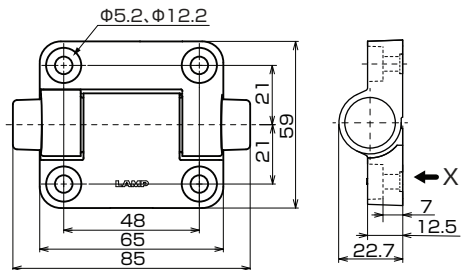

⚠ Screws not included  
Recommended screw and washer  
M5 hexagon socket head screw × 4  
washer 5mm in nominal diameter × 4

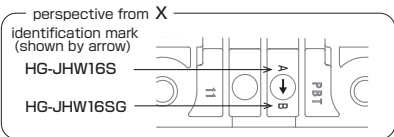

## 2. Specifications

Item No.	Moment N·m[kgf·cm]	UDH-16S Model No.(identification)
HG-JHW16S-34G	2.0~3.4[20.4~34.7]	M-type(Blue)
HG-JHW16S-50G	3.4~5.0[34.7~51.0]	H-type(Red)

※The moment indicated is at 1 pc use.

- Operating temperature : 0 to 40°C
- Operating humidity : Max90%RH
- ※The damper force is affected by room temperature.

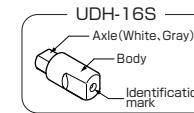

## 3. Damper Effective Angle

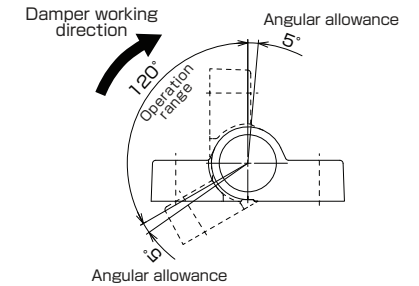

## 4. Installation Procedure

1. Fix the product to the cabinet referring to [3.Damper Effective Angle](#) and [6.Application Example](#) .

- ⚠ Tightening Torque : up to 2.0N·m
- ⚠ Do not use the impact screwdriver.

2. Open/close the door and check if the door moves smoothly and the damper is effective.

- ⚠ Do not apply excessive force to open the door or push down the door to close it with a hand.

## 5. Maximum Moment Calculation

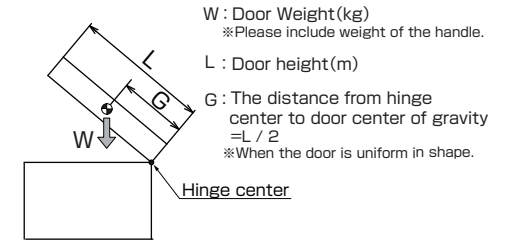

$$\text{Moment} = W \times G \times 9.80665(\text{N} \cdot \text{m})$$

## 6. Application Examples

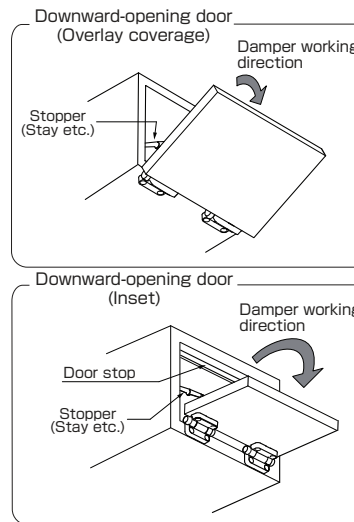

## ⚠ Caution : How to assemble the Damper Hinge

By any chance the product is disassembled, please re-assemble as per below

- 1 : Insert the UDH-16S into Part 1. (See [2.Specifications](#))

- ⚠ Part1 Confirm the identification mark on the back.

- ⚠ Make sure that the Axle and Identification Mark is correct. Wrong setup may cause breakage to the UDH-16S

- 2 : Insert Part2 and 3 to Part1.(See [1.Dimensions](#) )

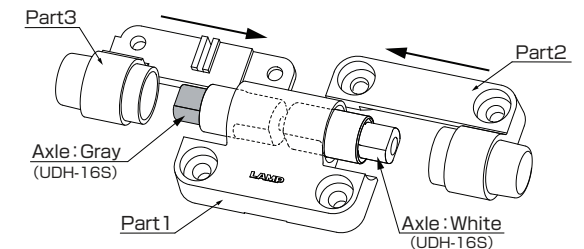

SUGATSUNE KOGYO CO.,LTD  
Tokyo, JAPAN  
Phone: +81 (0)3 3866 2260 E-mail:export@sugatsune.co.jp  
SUGATSUNE KOGYO (UK) LTD  
Reading, UK  
Phone: +44 118 9272 955 E-mail:sales@sugatsune.co.uk  
SUGATSUNE EUROPE GmbH  
Düsseldorf, GERMANY  
Phone: +49 211 53812900 E-mail:sales@sugatsune.eu

SUGATSUNE SHANGHAI Co., LTD  
Shanghai, CHINA  
Phone: +86 21 3632 1858 E-mail:lamp@sugatsune.com.cn  
Guangzhou, CHINA  
Phone: +86 20 6639 3552 E-mail:lamp@sugatsune.com.cn

SUGATSUNE KOGYO INDIA PRIVATE LIMITED  
Mumbai, INDIA  
Phone: +91 22 28314490/91 E-mail:sales@sugatsune.in

SUGATSUNE AMERICA, INC  
California, USA  
Phone: +1 310 329 6373 E-mail:sales@sugatsune.com  
Chicago, USA  
Phone: +1 312 461 1081 E-mail:chicagoshowroom@sugatsune.com

SUGATSUNE CANADA, INC.  
Phone: +1 514 312 5267 E-mail:support@sugatsune.ca

ISO9001(Japan Offices and Sugatsune America) and ISO14001(Chiba Production division and Logistics center), certified.